

Instruction Manual

Model 2582-344 Backup Switch

August 2009 Rev C

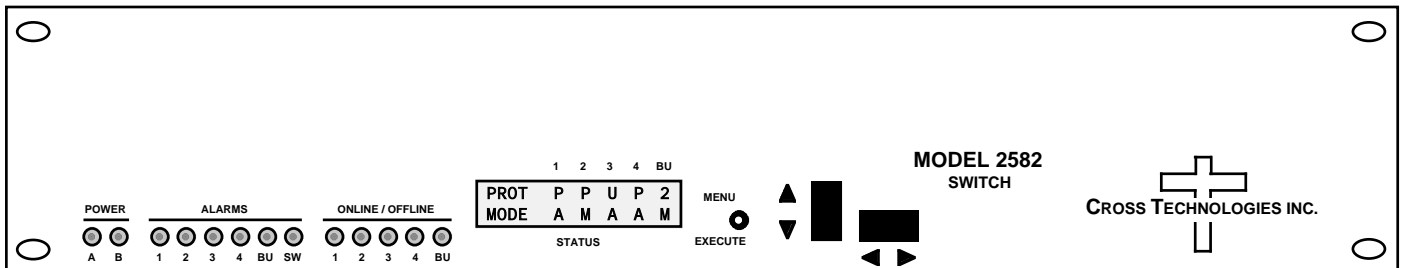

Data, drawings, and other material contained herein are proprietary to Cross Technologies, Inc., but may be reproduced or duplicated without the prior permission of Cross Technologies, Inc. for purposes of operating the equipment. Printed in USA.

When ordering parts from Cross Technologies, Inc., be sure to include the equipment model number, equipment serial number, and a description of the part.



6170 Shiloh Road
Alpharetta, Georgia 30005

(770) 886-8005
FAX (770) 886-7964
Toll Free 888-900-5588

WEB: www.crosstechnologies.com
E-MAIL: info@crosstechnologies.com

INSTRUCTION MANUAL

MODEL 2582-344 Switch

<u>TABLE OF CONTENTS</u>	<u>PAGE</u>
Warranty	2
1.0 General	3
1.1 Equipment Description	3
1.2 Technical Characteristics	5
1.3 Monitor & Control Interface	6
2.0 Installation	9
2.1 Mechanical	9
2.2 Rear I/O's	10
2.3 Front Panel Controls, Indicators	11
2.4 Operation	12
2.5 Menu Settings	13
3.0 Environmental Use Information	17

WARRANTY - The following warranty applies to all Cross Technologies, Inc. products.

All Cross Technologies, Inc. products are warranted against defective materials and workmanship for a period of one year after shipment to customer. Cross Technologies, Inc.'s obligation under this warranty is limited to repairing or, at Cross Technologies, Inc.'s option, replacing parts, subassemblies, or entire assemblies. Cross Technologies, Inc. shall not be liable for any special, indirect, or consequential damages. This warranty does not cover parts or equipment which have been subject to misuse, negligence, or accident by the customer during use. All shipping costs for warranty repairs will be prepaid by the customer. There are not other warranties, express or implied, except as stated herein.



6170 Shiloh Road
Alpharetta, Georgia 30005

(770) 886-8005
FAX (770) 886-7964
Toll Free 888-900-5588

WEB www.crosstechnologies.com
E-MAIL info@crosstechnologies.com

MODEL 2582-344 Switch, 1 for 4

1.0 General

1.1 Equipment Description

The 2582-344 1 for 4 Switch with Backup Controller provides Auto or Manual backup protection for up to 4 converters by relay switching two IF and one RF signal from a backup unit to any of 4 on-line units. The controller in the 2582-344 monitors alarms and settings of the on-line units and sets the backup unit to the parameters of the unit being backed up prior to backing it up. The 2582-344 works with standard Cross up and downconverters by polling their monitor and control ports on a periodic basis. A defective unit's inputs and outputs are switched from the failed unit to the backup when a failure occurs either automatically or manually. "On-line", "off-line" and "not used" modes can be programmed for each on-line converter. Alarms are contact closures to ground. Status of the 2582-344 is via a serial data stream and a contact closure to ground on alarm.

All settings are stored in nonvolatile ROM and on power up the 2582-344 polls all units. Manual Select is controlled by the multi-function switches on the front panel. LEDs indicate alarm and switch conditions. The unit is powered by two 100-240 \pm 10% VAC redundant power supplies, and housed in a 2RU chassis.

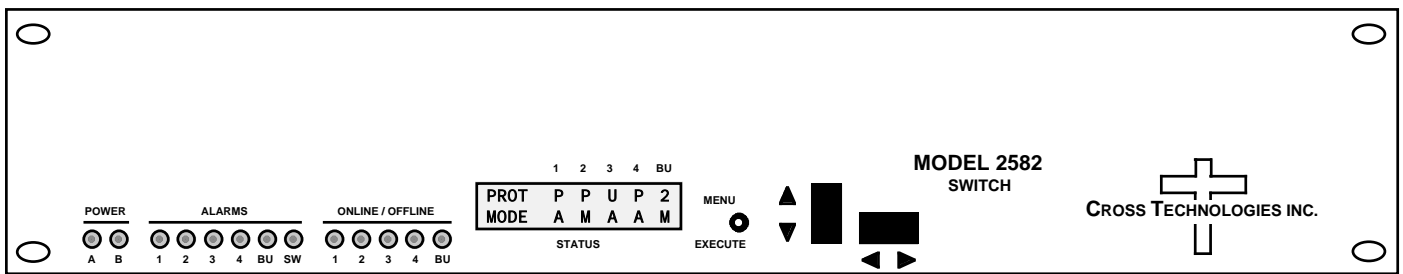

FRONT PANEL

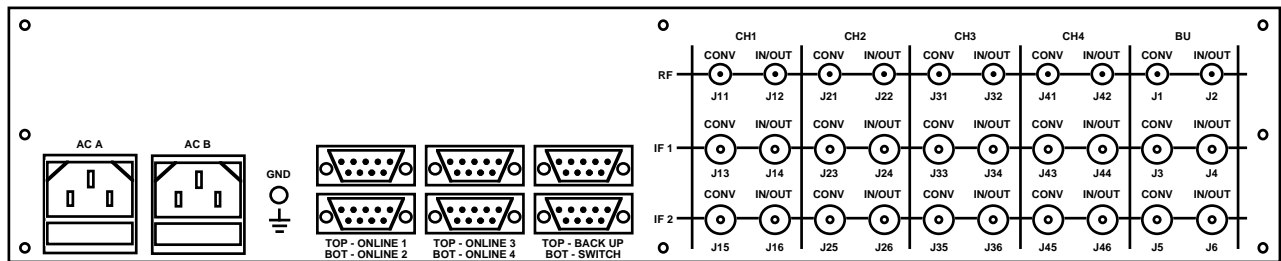

REAR PANEL

FIGURE 1.1 Model 2582-344 Front and Rear Panels

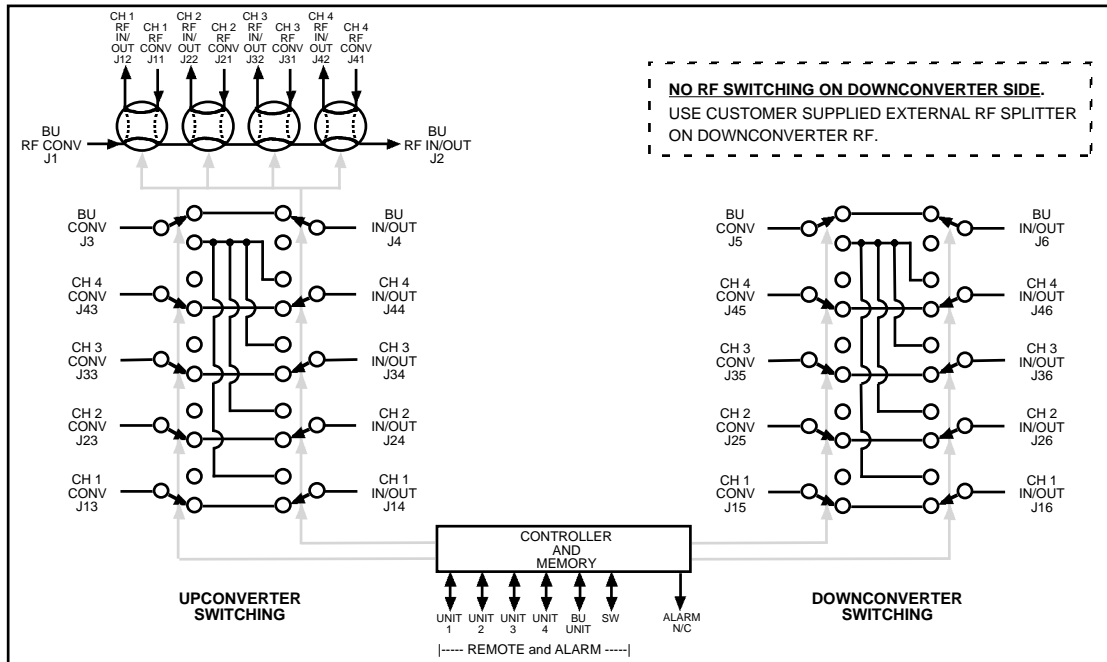

FIGURE 1.2 Model 2582-344 Switch Block Diagram

1.2 Technical Characteristics

TABLE 1.0 2582-344 Switch Specifications*

L-Band Switch Characteristics

Impedance	50 Ω
Return Loss	> 12 dB
Type	Relay
Isolation	> 55 dB, DC to 1.5 GHz; > 50 dB, to 2.2 GHz;
Switch time	\leq 100 milliseconds
Insertion Loss	\leq 1.5 dB, to 1.5 GHz; \leq 2.0 dB, to 2.2 GHz
Configuration	1 for 4, no termination

RF Switch Characteristics

Impedance	50 Ω
Return Loss	> 12 dB
Type	Relay
Isolation	> 60 dB, to 15 GHz
Switch time	\leq 100 milliseconds
Insertion Loss	\leq 1.5 dB, to 8 GHz; \leq 2.0 dB, to 15 GHz
Configuration	1 for 4, no termination

Controls, Indicators

Manual Selection	Push-button switches
Remote Selection	RS 232C/422/485 (selectable), 9600 baud
Power	Green LEDs
Alarms	Red LEDs
Online/Offline	Green LEDs

Other

RF Connectors	SMA (female)
L-Band Connectors	BNC (female)
Alarm/Remote Connectors	DB9 (female)
Size	19 inch, 2RU standard chassis 3.5" high X 16.0" deep
Power	100-240 \pm 10% VAC, 47-63 Hz, 45 watts max; Redundant power supplies

*+10°C to +40°C; Specifications subject to change without notice

1.3 Monitor and Control Interface

A) Remote serial interface

Protocol: RS-232C/422/485, 9600 baud rate, no parity, 8 data bits, 1 start bit, and 1 stop bit.

Connectors: Rear panel, DB-9 female

SWITCH Pinouts (RS-232C/422/485)	
Pin	Function
1	Rx-
2	Rx+ (RS-232C)
3	Tx+ (RS-232C)
4	Tx-
5	GND
6	Alarm Relay: Common
7	Alarm Relay: Normally Open
8	Not Used
9	Alarm Relay: Normally Closed

CH1,CH2,CH3,CH4,BU Pinouts	
Pin	Function
1	Tx-
2	Tx+ (RS-232C)
3	Rx+ (RS-232C)
4	Rx-
5	GND
6	Alarm Relay: Common
7	Alarm Relay: Normally Open
8	Not Used
9	Alarm Relay: Normally Closed

B) Status Requests Table 1.1 lists the status requests for the 2582-344 and briefly describes them

* PLEASE NOTE: The two character {aa}(00-31) prefix, in the table below, should be used ONLY when in RS-485 mode.

TABLE 1.1 2582-344 Status Requests		
Command	Syntax *	Description
Command Status	{aaS1}	Returns {aaS1bcdefghijklmno} where:
		• b = BACK-UP Status
		0 = Normal, no channels backed up
		1 = CH1 is currently backed up
		2 = CH2 is currently backed up
		3 = CH3 is currently backed up
		4 = CH4 is currently backed up
		• c = CH1 Status -- 0 = protected, 1 = unprotected
		• d = CH1 Mode -- 0 = AUTO, 1 = MANUAL, 2 = REMOTE
		• e = CH2 Status -- 0 = protected, 1 = unprotected
		• f = CH2 Mode -- 0 = AUTO, 1 = MANUAL, 2 = REMOTE
		• g = CH3 Status -- 0 = protected, 1 = unprotected
		• h = CH3 Mode -- 0 = AUTO, 1 = MANUAL, 2 = REMOTE
		• i = CH4 Status -- 0 = protected, 1 = unprotected
		• j = CH4 Mode -- 0 = AUTO, 1 = MANUAL, 2 = REMOTE
		• k = CH1 Alarm -- 0 = normal, 1 = alarm
		• l = CH2 Alarm -- 0 = normal, 1 = alarm
		• m = CH3 Alarm -- 0 = normal, 1 = alarm
		• n = CH4 Alarm -- 0 = normal, 1 = alarm
		• o = BACK-UP Alarm -- 0 = normal, 1 = alarm
		• p = Power Supply A Alarm -- 0 = normal, 1 = alarm
		• q = Power Supply B Alarm -- 0 = normal, 1 = alarm
Min. Auto Switching Status	{aaS5}	Returns {aaS5b} where:
		• b = Minimum Auto Switching mode status
		0 = Normal, Min. Auto Switching OFF
		1 = Min. Auto Switching ON

C) Commands Table 1.2 lists the commands for the 2582-344 and briefly describes them. After a command is sent the 2582-344 sends a return “>” indicating the command has been received and executed.

General Command Format - The general command format is {aaCND...}, where:

- { = start byte
- aa = address (**only used if in RS-485 mode**)
- C = 1 character, either C (command) or S (status)
- N = 1 character command or status request
- D = 1 character or more of data (depends on command)
- } = stop byte

* PLEASE NOTE: The two character {aa}(00-31) prefix, in the table below, should be used **ONLY** when in RS-485 mode.

Table 1.2 2582-344 Commands		
Command	Syntax*	Description
Set CH1 Status and Mode	{aaC1xy}	where:
		• x = 0; CH1 Protected
		• x = 1; CH1 Unprotected
		• y = 0; set CH1 to AUTO mode
		• y = 1; switch BACK-UP to CH1
Set CH2 Status and Mode	{aaC2xy}	where:
		• x = 0; CH2 Protected
		• x = 1; CH2 Unprotected
		• y = 0; set CH2 to AUTO mode
		• y = 1; switch BACK-UP to CH2
Set CH3 Status and Mode	{aaC3xy}	where:
		• x = 0; CH3 Protected
		• x = 1; CH3 Unprotected
		• y = 0; set CH3 to AUTO mode
		• y = 1; switch BACK-UP to CH3
Set CH4 Status and Mode	{aaC4xy}	where:
		• x = 0; CH4 Protected
		• x = 1; CH4 Unprotected
		• y = 0; set CH4 to AUTO mode
		• y = 1; switch BACK-UP to CH4
Set Min. Auto Switching Mode	{aaC5x}	where:
		• x = 0; Minimum Auto Switching DISABLED
		• x = 1; Minimum Auto Switching ENABLED
Restore Switch Position	{aaC6x}	where:
		• x = 1; Restore Switch Position after the switch position
		changed in Minimum Auto Switching mode

All external units (1, 2, 3, 4, and backup) can be controlled remotely via the 2582 switch. Converters to be controlled must be in RS-422 remote mode. Simply enter a prefix of *1, *2, *3, *4, or *5 for units 1, 2, 3, 4, or backup, respectively, before entering the corresponding unit’s status request or command. For example, to send a status command of S1 to converter #1 you would enter {aa*1S1}, where the address, aa, would only be necessary if the 2582 were in RS-485 mode. Any returned status will also be prefixed with a *1, *2, *3, *4, or *5.

2.0 Installation

2.1 Mechanical

The 2582-344 consists of two IF or L-Band Switching PCBs, one Controller PCB, and four baseball switches housed in a 2 RU (3 1/2 inch high) by 16 inch deep chassis. Two redundant switching, ± 12 , +24, +5 VDC power supplies provide power for the assembly. The 2582-344 can be secured to a rack using the 4 holes on the front panel. Figure 2.0 shows how the 2582-344 is assembled.

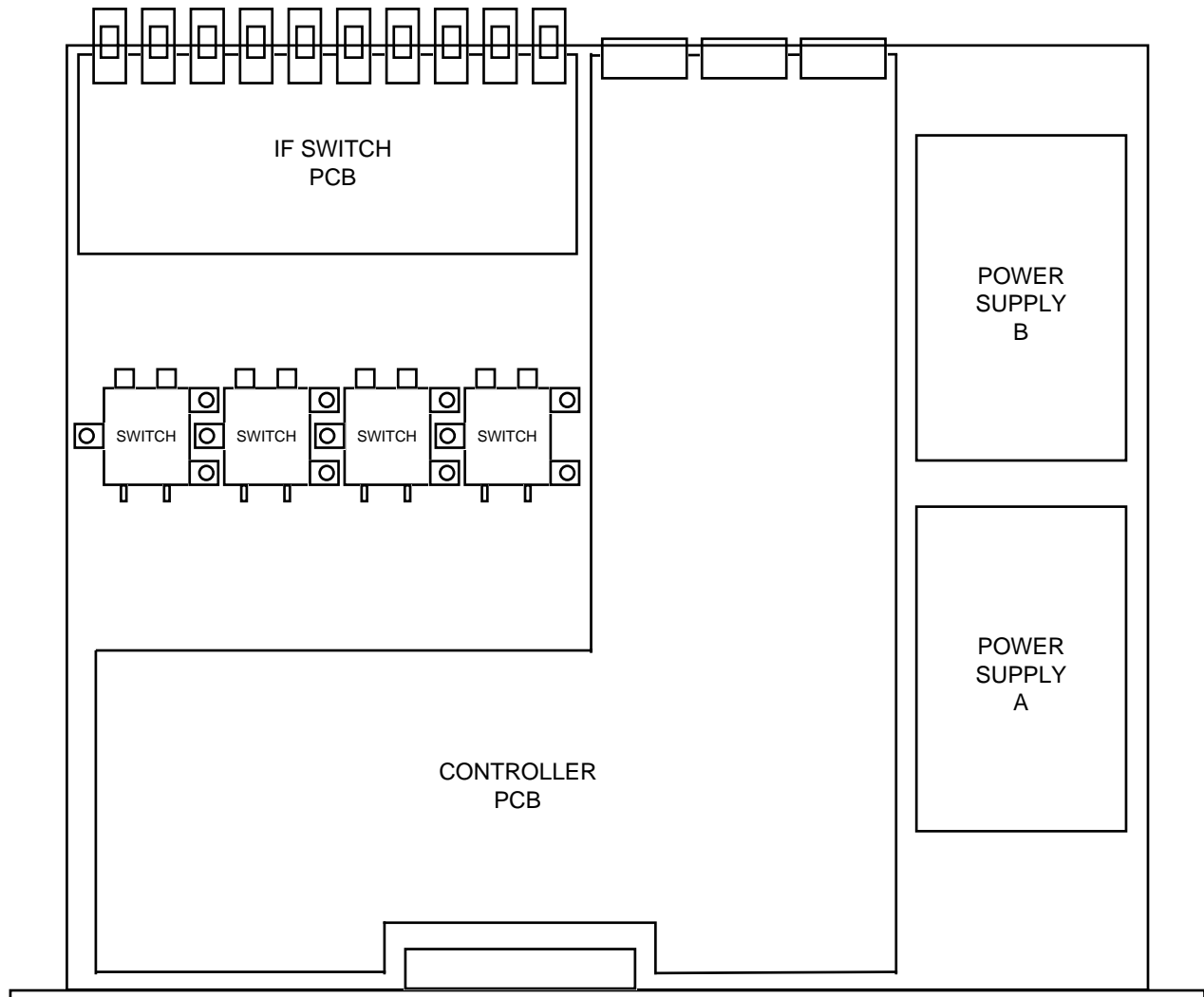

FIGURE 2.0 2582-344 Mechanical Assembly

2.2 Rear Panel Input/Output Signals

Figure 2.1 shows the input and output connectors on the rear panel.

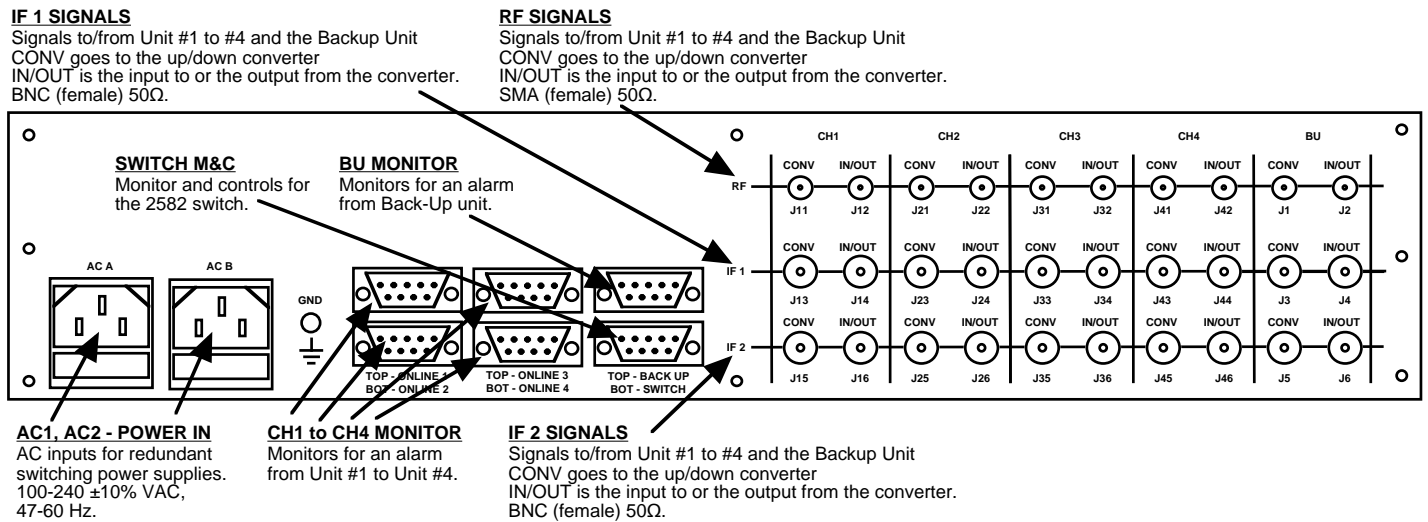

FIGURE 2.1 2582-344 Rear Panel I/O's

TABLE 2.1 SWITCH Pinouts (RS-232C/422/485)	
Pin	Function
1	Rx-
2	Rx+ (RS-232C)
3	Tx+ (RS-232C)
4	Tx-
5	GND
6	Alarm Relay: Common
7	Alarm Relay: Normally Open
8	Not Used
9	Alarm Relay: Normally Closed

TABLE 2.2 CH1,CH2,CH3,CH4,BU Pinouts	
Pin	Function
1	Tx-
2	Tx+ (RS-232C)
3	Rx+ (RS-232C)
4	Rx-
5	GND
6	Alarm Relay: Common
7	Alarm Relay: Normally Open
8	Not Used
9	Alarm Relay: Normally Closed

*Remote Serial Interface

Interface: DB-9 Male

Protocol: RS-232C/422/485, 9600 baud rate, no parity,
8 data bits, 1 start bit, 1 stop bit.

2.3 Front Panel Controls and Indicators

Figure 2.2 shows the front panel controls and indicators.

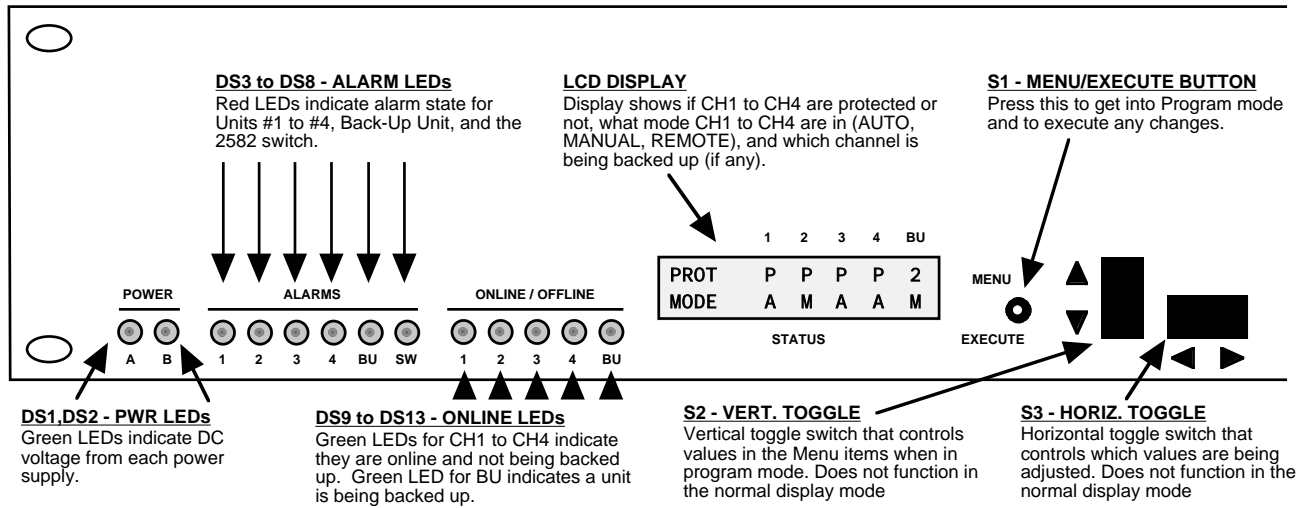

FIGURE 2.2 2582-344 Front Panel Controls and Indicators

2.4 Installation / Operation

2.4.1 Installing and Operating the 2582-344, Switch Section

1. Connect Converters (CH1, CH2, CH3, CH4, BU) to respective channels on the 2582 (Figure 2.1).
2. Connect Alarm/Control cables from Converters to respective monitors on the 2582 (Figure 2.1).
3. Connect two 100-240 \pm 10% VAC, 47 - 63 Hz power cords to AC A and AC B on the back panel (Figure 2.1).
4. Set which unit(s) you wish to protect and the mode for each unit (See Section 2.5 Menu Settings).
5. Be sure DS1 & DS2 (green, DC Power) are on and DS3 to DS8 (red, Alarm) are off (Figure 2.2).
6. AC Fuses - The fuses are 5 mm X 20 mm, 2 amp slow blow (Type T) and are inserted in the far slot in the drawer below the AC inputs as shown in Figure 2.3. There is a spare fuse in the near slot. If a fuse continues to open, the corresponding power supply is most likely defective.

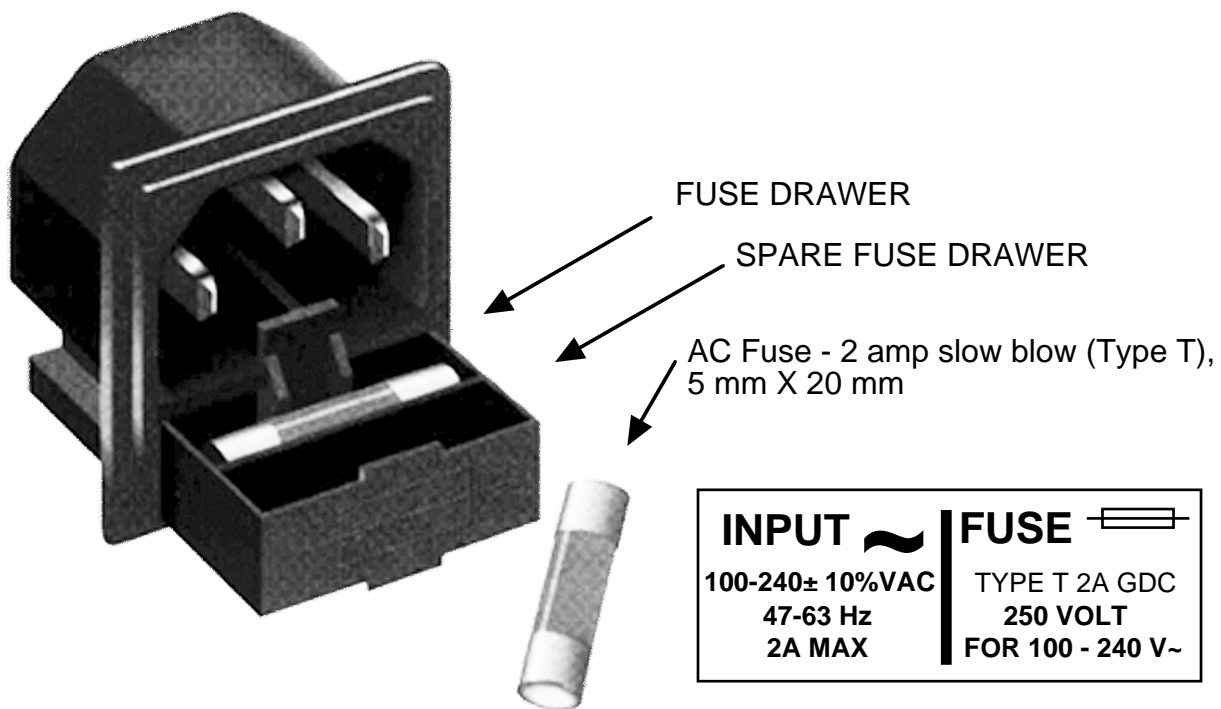

FIGURE 2.3 Fuse Location and Spare Fuse

2.5 Menu Settings

2.5.1 Functions - This section describes operation of the front panel controls. There are three operator switches, the LCD display and alarm indicator LEDs. All functions for the equipment are controlled by these components. The functions are (see Figure 2.4):

Power Up
Normal Display

Power Up
Normal Display

- Menu 1** Set CH1 Protected/Unprotected
- Menu 2** Set CH1 Mode (MANUAL overrides REMOTE which overrides AUTO)
- Menu 3** Set CH2 Protected/Unprotected
- Menu 4** Set CH2 Mode (MANUAL overrides REMOTE which overrides AUTO)
- Menu 5** Set CH3 Protected/Unprotected
- Menu 6** Set CH3 Mode (MANUAL overrides REMOTE which overrides AUTO)
- Menu 7** Set CH4 Protected/Unprotected
- Menu 8** Set CH4 Mode (MANUAL overrides REMOTE which overrides AUTO)
- Menu 9** Set Remote interface
- Menu 10** Set RS-485 address
- Menu 11** Set Minimum Auto Switching Mode ON and OFF
- Menu 12** Restore Switch Position in Minimum Auto Switching mode

Save Menu When “R” is selected or when get to the end

Alarm indications appear on the LEDs (see figure 2.2).

All program changes must start with the operation of the Menu/Execute switch and must also end with the operation of the Menu/Execute switch verified by the “Save Settings?” Menu. If this sequence is not followed, none of the changes will take effect.

2.5.2. Power On Settings

NOTE:The last status of a unit is retained even when power is removed. When power is restored, the unit will return to it's previous settings.

When power is first applied, the LCD display goes through three steps.

- 1.The LCD goes black to show all segments are functioning.
- 2.The software version will be displayed.

1 2 3 4 BU

REV 1.00

STATUS

- 3.The present protection state and mode of each channel/unit are shown.

1 2 3 4 BU

PROT	P	P	P	P	
MODE	A	A	A	A	A

STATUS

The unit is now operational and ready for any changes the operator may desire.

2.5.3 Control Switches

1. Menu/Execute - Any change to the programming of the unit must be initiated by pressing the Menu/Execute switch and completed by pressing the Menu/Execute switch.
2. Horizontal Switch - This switch is mounted so its movement is horizontal and moves the cursor left or right.
3. Vertical Switch - This switch is mounted so its movement is vertical, and changes settings in each menu.

2.5.4 Alarm Indications

An alarm condition will occur if the corresponding unit's local oscillator phase lock loop (PLL) comes out of lock (when connected properly).

	ON POWER UP																				
Power Up	REV 1.00																				
<hr/>																					
	NORMAL DISPLAY																				
		1	2	3	4	BU															
Normal Display	<table border="1" style="width: 100%; border-collapse: collapse;"> <tr> <td style="padding: 2px;">PROT</td> <td style="padding: 2px;">P</td> <td style="padding: 2px;">P</td> <td style="padding: 2px;">P</td> <td style="padding: 2px;">P</td> <td style="padding: 2px;">P</td> <td style="padding: 2px;">P</td> </tr> <tr> <td style="padding: 2px;">MODE</td> <td style="padding: 2px;">A</td> <td style="padding: 2px;">A</td> <td style="padding: 2px;">A</td> <td style="padding: 2px;">A</td> <td style="padding: 2px;">A</td> <td style="padding: 2px;">A</td> </tr> </table>						PROT	P	P	P	P	P	P	MODE	A	A	A	A	A	A	PUSH BUTTON
PROT	P	P	P	P	P	P															
MODE	A	A	A	A	A	A															
	STATUS																				
<hr/>																					
	PUSHING MENU/EXECUTE SEQUENCE																				
Menu 1 Set CH1 protection	<table border="1" style="width: 100%; border-collapse: collapse;"> <tr> <td style="padding: 2px;">CH1 = _</td> <td style="padding: 2px;">R</td> </tr> <tr> <td colspan="2" style="padding: 2px;">Protected</td> </tr> </table>					CH1 = _	R	Protected		SCROLL <> SCROLL ⬅	PUSH BUTTON										
CH1 = _	R																				
Protected																					
Menu 2 Set CH1 mode	<table border="1" style="width: 100%; border-collapse: collapse;"> <tr> <td style="padding: 2px;">CH1 = _</td> <td style="padding: 2px;">R</td> </tr> <tr> <td colspan="2" style="padding: 2px;">Auto</td> </tr> </table>					CH1 = _	R	Auto		SCROLL <> SCROLL ⬅	PUSH BUTTON										
CH1 = _	R																				
Auto																					
Menu 3 Set CH2 protection	<table border="1" style="width: 100%; border-collapse: collapse;"> <tr> <td style="padding: 2px;">CH2 = _</td> <td style="padding: 2px;">R</td> </tr> <tr> <td colspan="2" style="padding: 2px;">Protected</td> </tr> </table>					CH2 = _	R	Protected		SCROLL <> SCROLL ⬅	PUSH BUTTON										
CH2 = _	R																				
Protected																					
Menu 4 Set CH2 mode	<table border="1" style="width: 100%; border-collapse: collapse;"> <tr> <td style="padding: 2px;">CH2 = _</td> <td style="padding: 2px;">R</td> </tr> <tr> <td colspan="2" style="padding: 2px;">Auto</td> </tr> </table>					CH2 = _	R	Auto		SCROLL <> SCROLL ⬅	PUSH BUTTON										
CH2 = _	R																				
Auto																					
Menu 5 Set CH3 protection	<table border="1" style="width: 100%; border-collapse: collapse;"> <tr> <td style="padding: 2px;">CH3 = _</td> <td style="padding: 2px;">R</td> </tr> <tr> <td colspan="2" style="padding: 2px;">Protected</td> </tr> </table>					CH3 = _	R	Protected		SCROLL <> SCROLL ⬅	PUSH BUTTON										
CH3 = _	R																				
Protected																					
Menu 6 Set CH3 mode	<table border="1" style="width: 100%; border-collapse: collapse;"> <tr> <td style="padding: 2px;">CH3 = _</td> <td style="padding: 2px;">R</td> </tr> <tr> <td colspan="2" style="padding: 2px;">Auto</td> </tr> </table>					CH3 = _	R	Auto		SCROLL <> SCROLL ⬅	PUSH BUTTON										
CH3 = _	R																				
Auto																					
Menu 7 Set CH4 protection	<table border="1" style="width: 100%; border-collapse: collapse;"> <tr> <td style="padding: 2px;">CH4 = _</td> <td style="padding: 2px;">R</td> </tr> <tr> <td colspan="2" style="padding: 2px;">Protected</td> </tr> </table>					CH4 = _	R	Protected		SCROLL <> SCROLL ⬅	PUSH BUTTON										
CH4 = _	R																				
Protected																					
Menu 8 Set CH4 mode	<table border="1" style="width: 100%; border-collapse: collapse;"> <tr> <td style="padding: 2px;">CH4 = _</td> <td style="padding: 2px;">R</td> </tr> <tr> <td colspan="2" style="padding: 2px;">Auto</td> </tr> </table>					CH4 = _	R	Auto		SCROLL <> SCROLL ⬅	PUSH BUTTON										
CH4 = _	R																				
Auto																					
Menu 9 Set Remote Mode	<table border="1" style="width: 100%; border-collapse: collapse;"> <tr> <td style="padding: 2px;">RS 485 OFF</td> <td style="padding: 2px;">R</td> </tr> </table>					RS 485 OFF	R	SCROLL <> SCROLL ⬅	PUSH BUTTON												
RS 485 OFF	R																				
Menu 10 Set RS-485 Address	<table border="1" style="width: 100%; border-collapse: collapse;"> <tr> <td style="padding: 2px;">ADDRESS = 00</td> <td style="padding: 2px;">R</td> </tr> </table>					ADDRESS = 00	R	SCROLL <> SCROLL ⬅	PUSH BUTTON												
ADDRESS = 00	R																				
Menu 11 Set Min. Auto Switching	<table border="1" style="width: 100%; border-collapse: collapse;"> <tr> <td style="padding: 2px;">Minimum Auto Switching=ON</td> <td style="padding: 2px;">R</td> </tr> </table>					Minimum Auto Switching=ON	R	SCROLL <> SCROLL ⬅	PUSH BUTTON												
Minimum Auto Switching=ON	R																				
Menu 12 Restore Switch	<table border="1" style="width: 100%; border-collapse: collapse;"> <tr> <td style="padding: 2px;">Restore Sw=OFF</td> <td style="padding: 2px;">R</td> </tr> </table>					Restore Sw=OFF	R	SCROLL <> SCROLL ⬅	PUSH BUTTON												
Restore Sw=OFF	R																				
Save? When "R" is selected from any above menu or at the end	<table border="1" style="width: 100%; border-collapse: collapse;"> <tr> <td style="padding: 2px;">SAVE SETTINGS? Y N</td> <td style="padding: 2px;">R</td> </tr> </table>					SAVE SETTINGS? Y N	R	SCROLL <>	PUSH BUTTON												
SAVE SETTINGS? Y N	R																				

FIGURE 2.4 Menu Display and Sequences

2.5.5 Minimum Auto Switching Mode

Enabling and Disabling

The Minimum Auto Switching mode is enabled and disabled via a front panel menu.

The Minimum Auto Switching mode can also be enabled and disabled via the following M&C command:

{C5x}

Where x=1 to enable and x=0 to disable.

The status of the 2582-3xx's Minimum Auto Switching mode setting can be queried by sending the following command:

{S5}

Which returns {S5x} where x=1 if enabled and x=0 if disabled.

Operation

In the Minimum Auto Switching mode the switch will remain in a backup state after an alarm event - even if the alarm event that caused the unit to switch has been cleared. The main display will show an "H" under the BU MODE after an alarm causes the switch to change states while in the Minimum Auto Switching mode. The unit can be restored to the normal state via a front panel restore command or an M&C restore command. The front panel Restore Switch menu appears after the Minimum Auto Switching mode ON/OFF menu only if the Minimum Auto Switching mode is on. The switch can also be restored via the following M&C command:

{C6x}

Where x=1 to restore.

NOTE: The switch will automatically restore - as soon as the alarm event that caused the unit to switch has been cleared - *IF* the Minimum Auto Switching mode is disabled either via the front panel setting or by the M&C command.

3.0 Environmental Use Information

- A. Rack-Mounting** - To mount this equipment in a rack, please refer to the installation instructions located in the user manual furnished by the manufacturer of your equipment rack.
- B. Mechanical Loading** - Mounting of equipment in a rack should be such that a hazardous condition does not exist due to uneven weight distribution.
- C. Elevated Operating Ambient Temperature** - If installed in a closed or multi-unit rack assembly, the operating ambient temperature of the rack may be greater than room ambient temperature. Therefore, consideration should be given to Tmra.
- D. Reduced Air Flow** - Installation of the equipment in a rack should be such that the amount of air flow required for safe operation of the equipment is not compromised. Additional space between unit may be required.
- E. Circuit Overloading** - Consideration should be given to the connection of the equipment to the supply circuit and the effect that overloading of circuits could have on over current protection and supply wiring. Appropriate consideration of equipment name plate rating should be used, when addressing this concern.
- F. Reliable Earthing** - Reliable earthing of rack-mounted equipment should be maintained. Particular attention should be given to supply connections other than direct connection to the Branch (use of power strips).
- G. Top Cover** - There are no serviceable parts inside the product so, the Top Cover should not be removed. If the Top Cover is removed the ground strap and associated screw **MUST BE REINSTALLED** prior to Top Cover screw replacement. **FAILURE TO DO** this may cause **INGRESS** and/or **EGRESS** emission problems.



6170 Shiloh Road
Alpharetta, Georgia 30005

(770) 886-8005
FAX (770) 886-7964
Toll Free 888-900-5588

WEB www.crosstechnologies.com
E-MAIL info@crosstechnologies.com

Printed in USA